

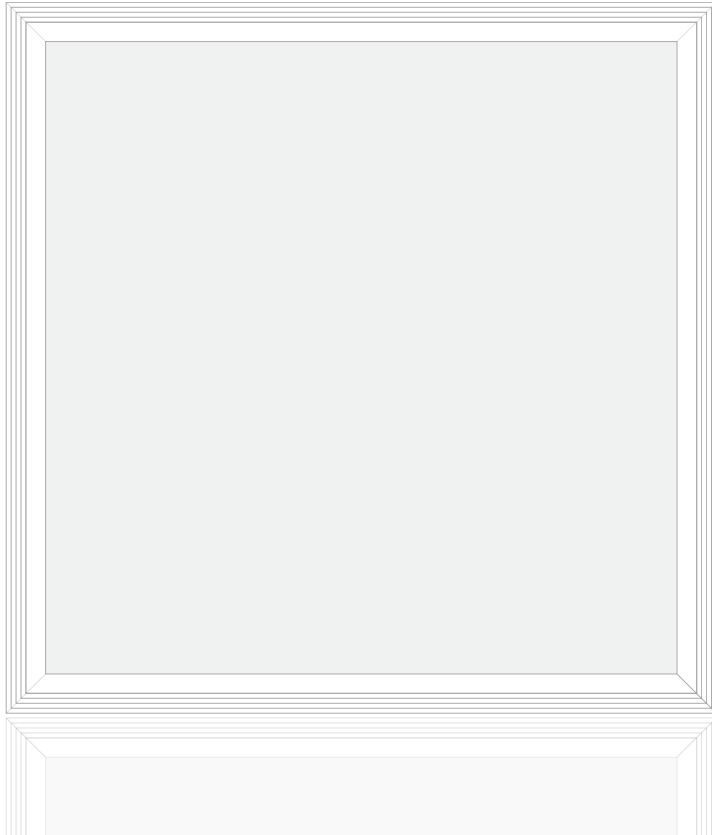

ROCKLAND LED LLC.

201 Main St. Nyack, NY 10960 | (845) 300-9399 | billn@rocklandled.com | www.rocklandled.com



Features & Benefits:

- Longbright power supply
- Super bright LM80 LED 0.5W 2835SMD, Ra>80
- Lumen output : 110-120lm/w DLC4.0 Standard
125-140lm/w DLC4.0 Premium
- Longbright brand isolated driver, PF>0.9, THD≤ 15 %
- AC100-277V, 0-10V dimmable
- Anti-Yellowing 3mm thick PMMA LGP
- Over 80% energy saving versus fluorescent lamps
- 5 - 7 days delivery
- UL cUL DLC certifications
- Ideal replacement for traditional troffer
- 5 Years warranty

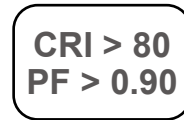

Specifications



Technical Specification

Input Voltage: AC100V~277V 50Hz~60Hz

THD: $\leq 15\%$

PF: >0.90

Power Efficiency: $>90\%$

LED light source: SMD2835

Color Temperature: 3000K, 4000K, 5000K

Color Rendering Index: CRI >80

Beam Angle: 120°

Material: AL+PMMA+PS

Working Temperature: $-20^\circ\text{C} \sim +45^\circ\text{C}$

Storage Temperature: $-25^\circ\text{C} \sim +65^\circ\text{C}$

IP Grade : IP44

Working Life-span: $>50,000\text{Hrs}$

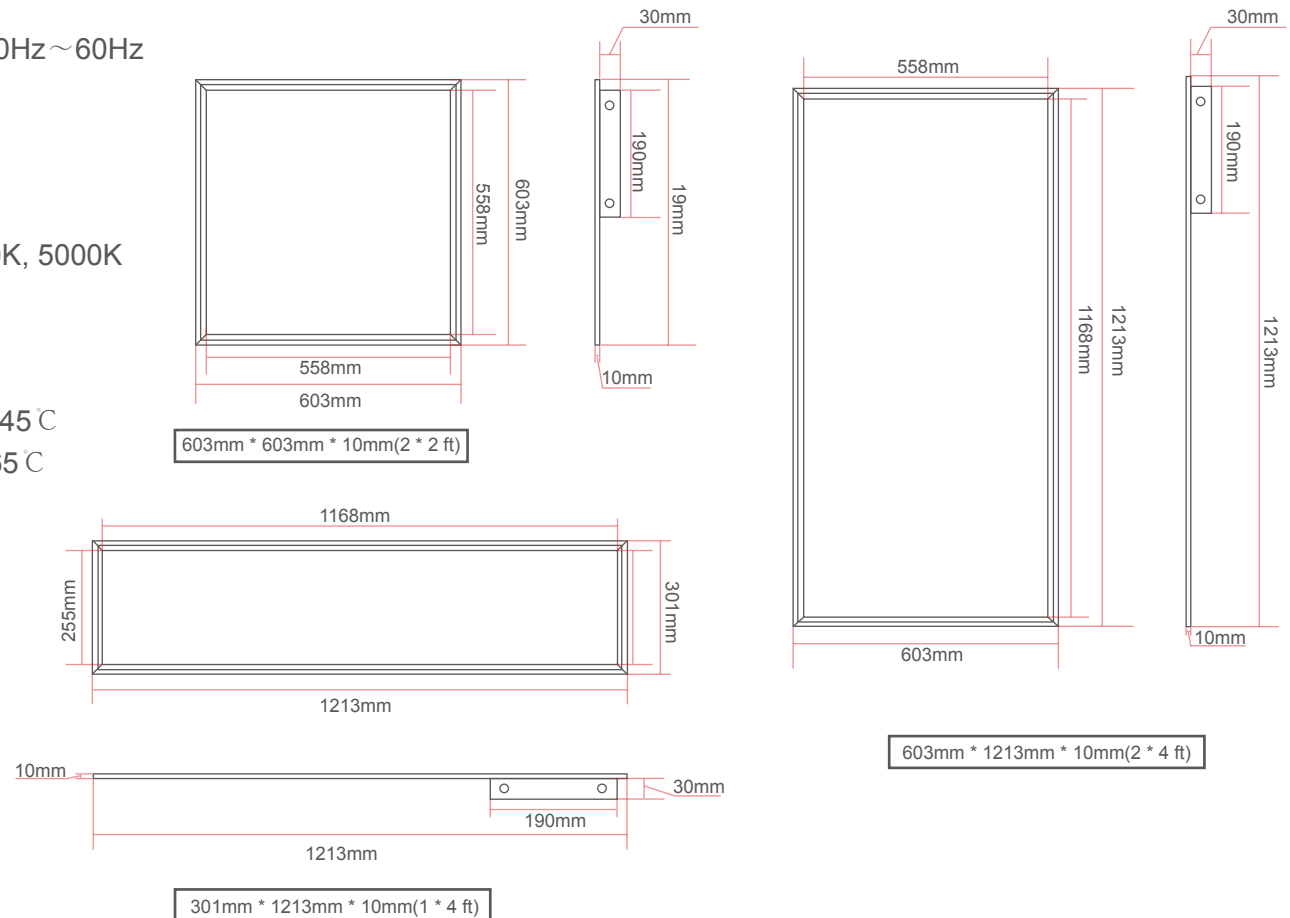

Specifications



DLC4.0 Standard

Model	Watt	Input Voltage	Lumens	SMD2835 LED Qty	Size	Efficiency	CCT	N.W
PL-36W-66-28-TG-01	36W	100-277V AC	3960(1 ± 5%)lm	192 pcs	2 * 2 ft 603*603mm	110-120lm/w	3000K	3.7 kg/pc
PL-40W-66-28-TG-07	40W		4400(1 ± 5%)lm					3.7 kg/pc
PL-45W-66-28-TG-01	45W		4950(1 ± 5%)lm					3.7 kg/pc
PL-40W-123-28-TG-07	40W		4400(1 ± 5%)lm	192 pcs	1 * 4 ft 1213*301mm		3500K	3.8 kg/pc
PL-45W-123-28-TG-01	45W		4950(1 ± 5%)lm				4000K	3.8 kg/pc
PL-50W-126-28-TG-05	50W		5500(1 ± 5%)lm	336 pcs	2 * 4 ft 1213*603mm		4500K	7.2 kg/pc
PL-60W-126-28-TG-05	60W		6600(1 ± 5%)lm				5000K	7.2 kg/pc
PL-72W-126-28-TG-13	72W		7920(1 ± 5%)lm				7.2 kg/pc	

Specifications



DLC4.0 Premium

Model	Watt	Input Voltage	Lumens	SMD2835 LED Qty	Size	Efficiency	CCT	N.W
PL-35W-66-28-TG-01	35W	100-277V AC	4550(1 ± 5%)lm	192 pcs	2 * 2 ft 603*603mm	125-140lm/w	3000K	3.7 kg/pc
PL-40W-66-28-TG-01	40W		5200(1 ± 5%)lm					3.7 kg/pc
PL-40W-123-28-TG-01	40W		5200(1 ± 5%)lm	192 pcs	1 * 4 ft 1213*301mm		4000K	3.8 kg/pc
PL-50W-126-28-TG-01	50W		6500(1 ± 5%)lm	384 pcs	2 * 4 ft 1213*603mm		5000K	7.2 kg/pc
PL-60W-126-28-TG-01	60W		7800(1 ± 5%)lm					7.2 kg/pc

Exploded view

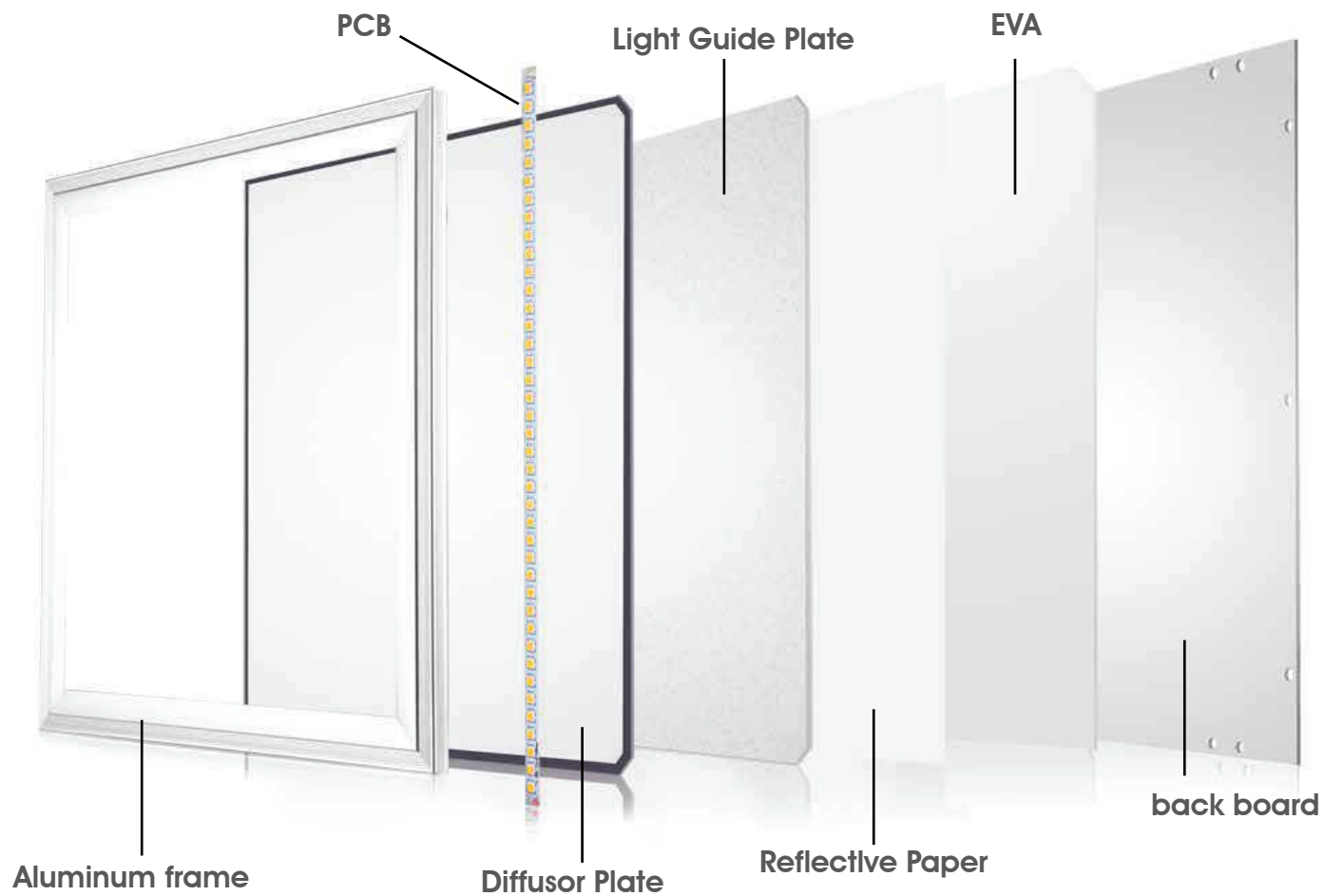

Aluminum Frame



Quality you can depend on.



Laser aluminum radiator

Anodized anti-corrosion coated Aluminum housing.

Led Light Source



SMD 2835



VS

SMD 4014

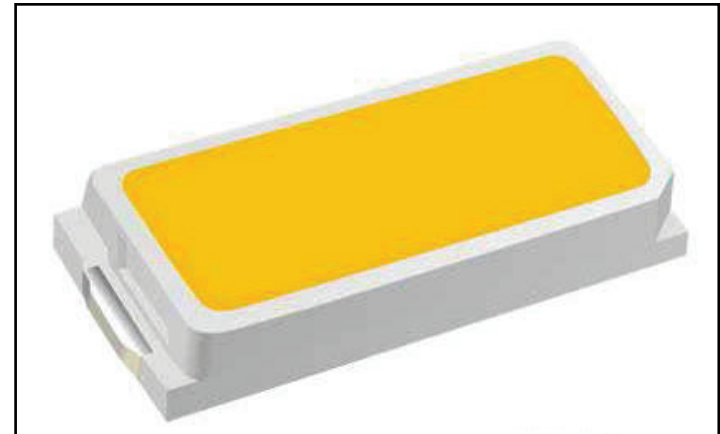

Model	size	Emitting style	Emitting area	Radiating			Beam angle	Lumen
				Style	Area	Effect		
SMD4014	4.0*1.4*0.8	Positive luminescence	5.6mm ²	Heat sink	Small	Bad	90	20-22lm
SMD2835	2.8*3.5*0.8	Positive luminescence	9.18mm ²	Heat sink	Big	Good	120	50-60lm

Obviously, the light-emitting surface, luminous flux, thermal performance and other aspects of smd2835 are better than smd4014

Led Light Source



Ours



SMD 2835 0.5W

2 * 2 ft

Ours: SMD 2835 0.5W 192pcs 36W Power Load 37%

Other: SMD 4014 0.2W 192pcs 36W Power Load 93.8%

1 * 4 ft

Ours: SMD 2835 0.5W 192pcs 45W Power Load 46%

Other: SMD 4014 0.2W 216pcs 45W Power Load 104%

Others

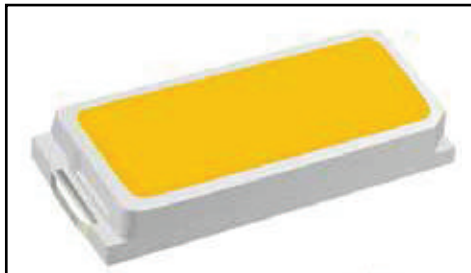

SMD 4014 0.2W

2 * 4 ft

Ours: SMD 2835 0.5W 336pcs 72W Power Load 43%

Other: SMD 4014 0.2W 384pcs 72W Power Load 94%

The full power load of panel lights with SMD 4014 LED chips is about 100%. The full power load of panel lights with SMD 2835 LED chips is about 40%. The higher service load over time leads to uneven brightness, dark spots, a yellowing color affect, and decreased service life.

Light Guide Plate



PMMA LIGHT GUIDE PLATE

The Light Guide Plate is an acrylic panel made from pure PMMA resin. PMMA is a transparent thermoplastic used in sheet form as a lightweight, shatter-resistant alternative to glass. The Light Guide Plate directs the light evenly across the front of the panel.

PMMA Light Guide Plate

Reflective Paper



- Material: PET
- Diameter: 450*500mm or customizing
- Thickness: 0.23/0.3/0.5mm
- Heat resistant: >150C
- Reflective light efficiency: >99%

Package



DLC / UL Package

Size	Qty	Carton size(mm)	N.W.	G.W.
2 * 2 ft	4	670 * 230 * 690	3.7 kg * 4	18.0 kg
1 * 4 ft	4	1280 * 230 * 390	3.8 kg * 4	18.8 kg
2 * 4 ft	2	1280 * 120 * 390	7.2 kg * 2	17.3 kg



Mounting Kits



Earthquake Proof Hooks

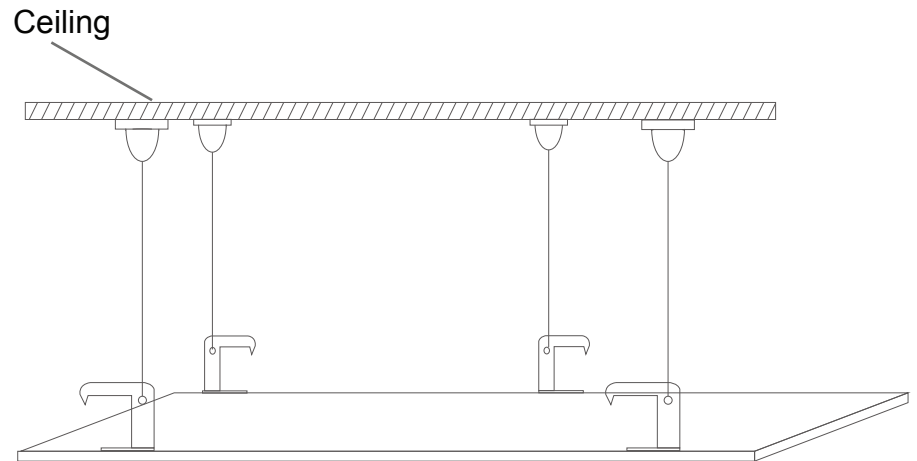
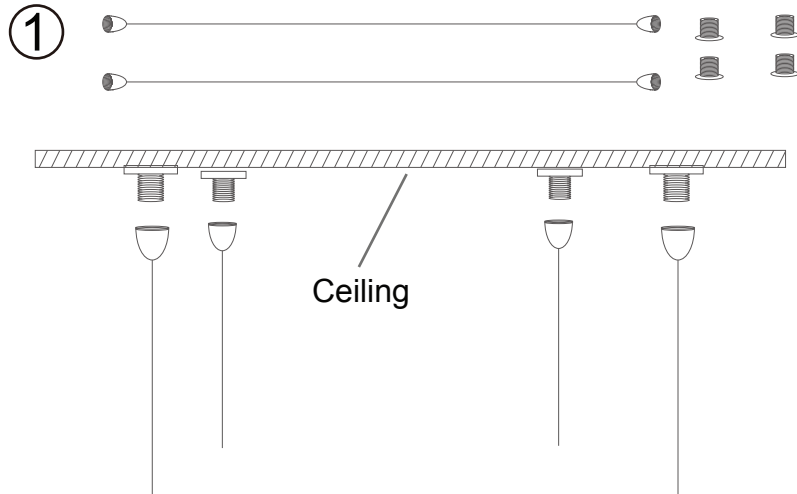
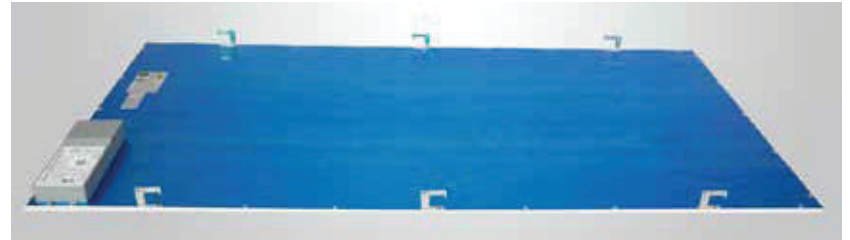

Mounting Kits



②

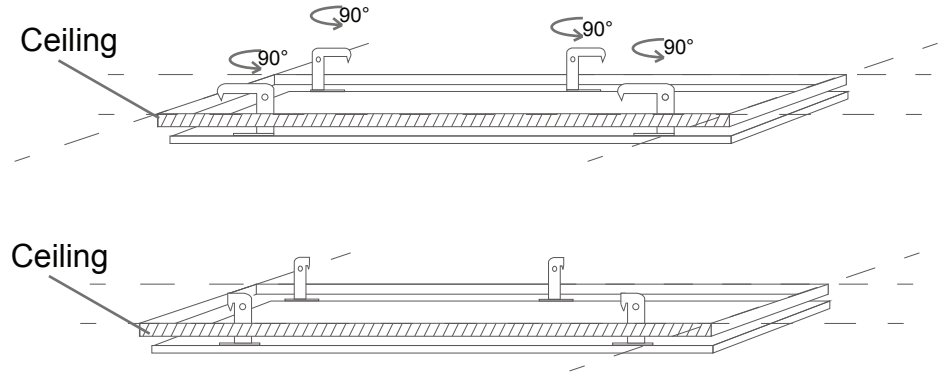
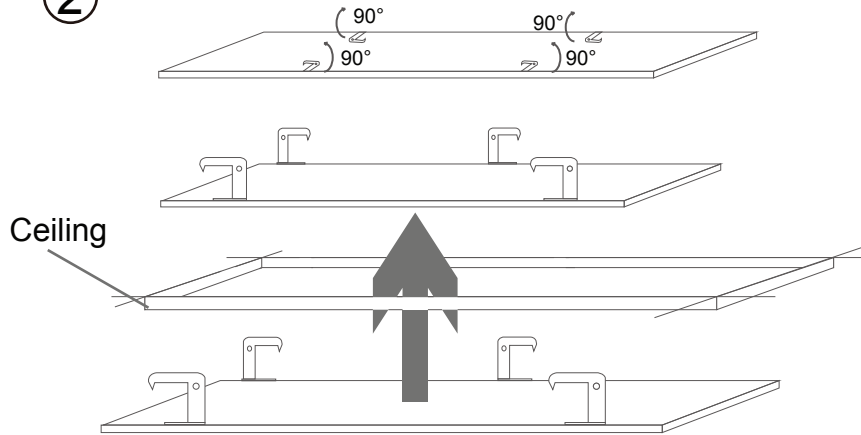

Surface mounting frame

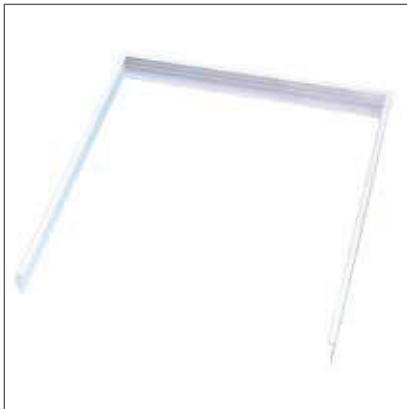

Suspension Kits

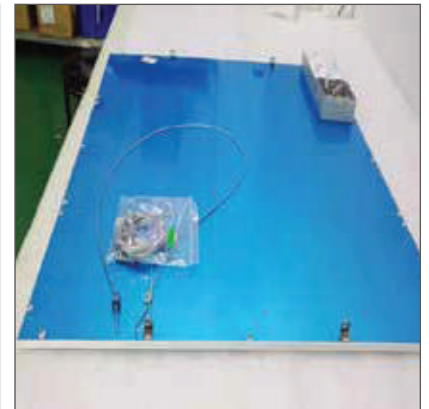

Installations



Recessed into ceiling

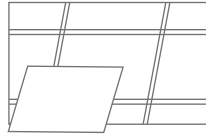

1.Remove ceiling plaster slab

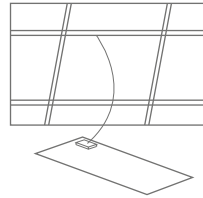

2. Connect power supply

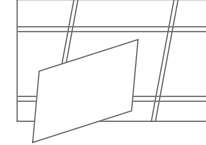

3. Fix the panel light into right place

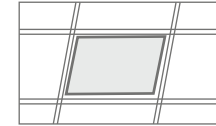

4.Stabilize the panel

Suspending

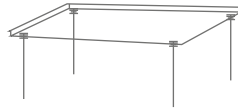

1. A.Fix the anchor into target place on the ceiling.
B.Fix the installation mount on the ceiling with plastic anchor.

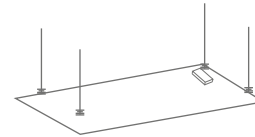

2.Hang the panel to ceiling with suspending installation kits

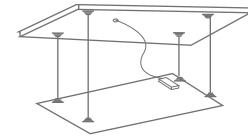

3. Adjust the length of steel wire.Connect the power supply

surface mounted

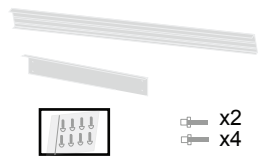

1.Unpack box and take out aluminum profile A-2pcs, aluminum profile B-2pcs,as well as accessory pack

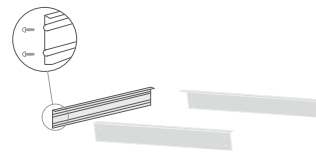

2.Assembling 3 pieces aluminum profile together with screw.

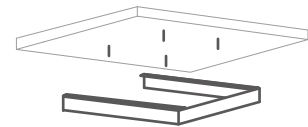

3.Fix semi-finished frame onto ceiling with screw(Concrete ceiling requires plastic anchor)

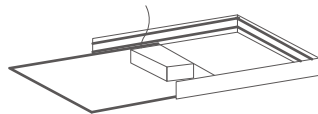

4.slide panel into frame properly

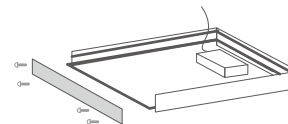

5.Fix the last piece of aluminum profile with screw after panel is well placed.

**LIGHTING THE WORLD
ILLUMINATING THE FUTURE**

ROCKLAND LED LLC.

201 Main St. Nyack, NY 10960 | (845) 300-9399 | billn@rocklandled.com | www.rocklandled.com